

Q 15

TWO-WAY POINT SOURCE MODULE

DESCRIPTION

Q 15 is a two-way, bi-amp point source module for mid-distance and long-throw applications, combining a compact size with very high output and accurate speech and music reproduction. The system is equipped with the latest generation of RCF precision transducers featuring one 15" neodymium woofer and a 4" titanium-neodymium compression driver for a total of 1500 W power rating and 60° (vertical) and 22.5° (horizontal) directivity. The enclosure shape is trapezoidal and offers a 22.5° coupling angle on each side.

Q Series typical applications span from point-source configurations for mid-distance applications to clusters up to 8 modules for long-throw applications. The grille is epoxy-coated, with a woven fabric backing for dust protection. The cabinet is made of multi-ply Baltic birch plywood with a highly resistant, textured, black polyurea finishing and features two rear-panel Neutrik Speakon NL4 connections for bi-amplification (4 poles)



FEATURES

- 138 dB Max SPL
- 1500 W AES power handling
- 45 ÷ 20000 Hz
- 60° x 22.5° constant directivity coverage
- 1 x 15" neodymium woofer, 4.0" v.c.
- 4" neodymium compression driver
- Baltic birch plywood cabinet
- Steel front grille with clothing
- Integrated array mechanics
- Multi-pole Speakon connectors

TECHNICAL SPECIFICATIONS

Acoustical specifications	Frequency Response (-10dB):	45 Hz ÷ 20000 Hz
	Max SPL @ 1m:	138 dB
	Horizontal coverage angle:	22.5°
	Vertical coverage angle:	60°
	Directivity index Q:	20
	System Sensitivity:	98 dB
Power section	Amplification:	Bi-Amp
	Nominal Impedance LF:	8 ohm
	Power Handling LF:	1350 W
	Peak Power Handling LF:	5400 W
	Recommended Amplifier LF:	2700 W
	Nominal Impedance HF:	8 ohm
	Power Handling HF:	150 W
	Peak Power Handling HF:	600 W
	Recommended Amplifier HF:	300 W
Protections HF:	Capacitor on Compression Driver	
Transducers	Compression Driver:	1 x 1.4" neo, 4.0" v.c
	Woofers:	15" neo, 4.0" v.c
Input/Output section	Input connectors:	Speakon® NL4
	Output connectors:	Speakon® NL4
Standard compliance	CE marking:	Yes
Physical specifications	Cabinet/Case Material:	Baltic birch plywood
	Hardware:	Side and rear array rigging point
	Handles:	2
	Grille:	Steel
	Color:	Black - RAL 9005
Size	Height:	860 mm / 33.86 inches
	Width:	446 mm / 17.56 inches
	Depth:	590 mm / 23.23 inches
	Weight:	55 kg / 121.25 lbs
Shipping informations	Package Height:	9650 mm / 379.92 inches
	Package Width:	5850 mm / 230.32 inches
	Package Depth:	7750 mm / 305.12 inches
	Package Weight:	59 kg / 130.07 lbs



PART NUMBER

- **13000698**

Q 15

EAN 8024530018726

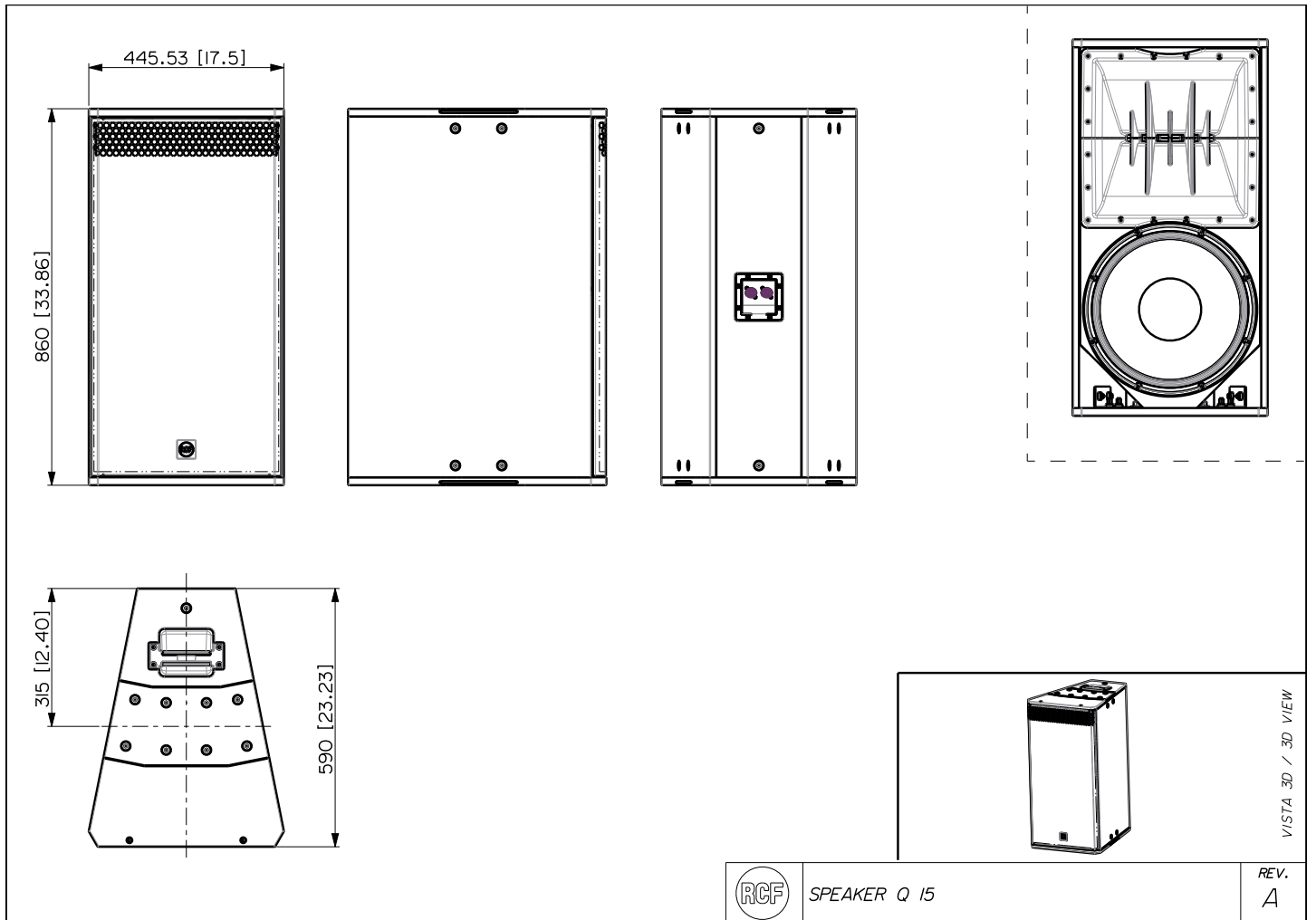

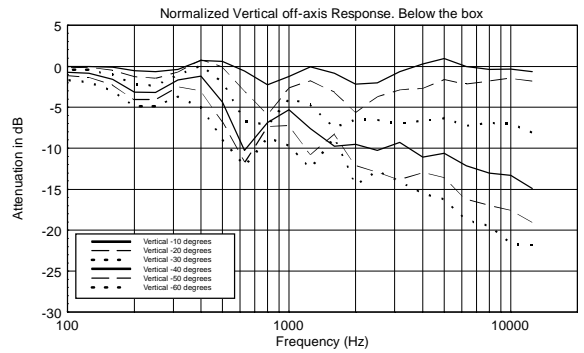
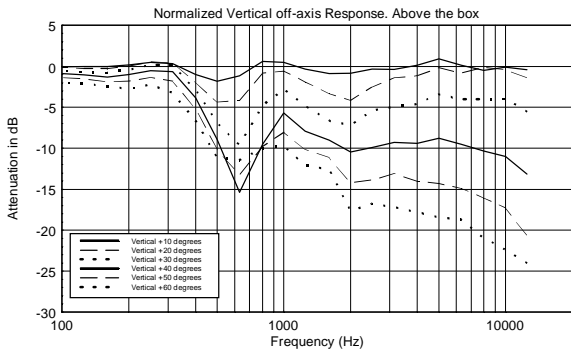
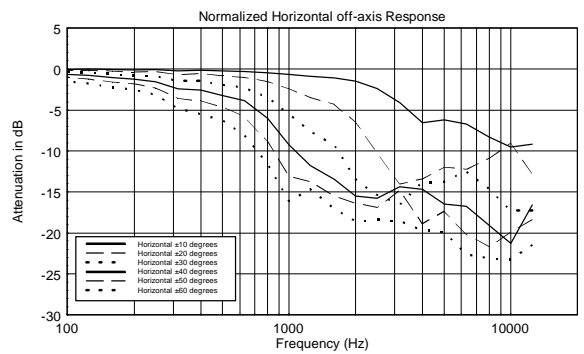
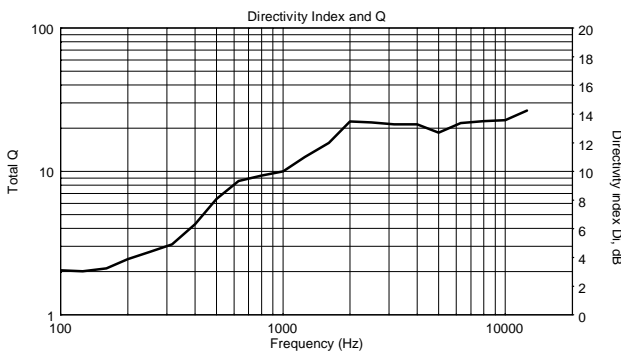
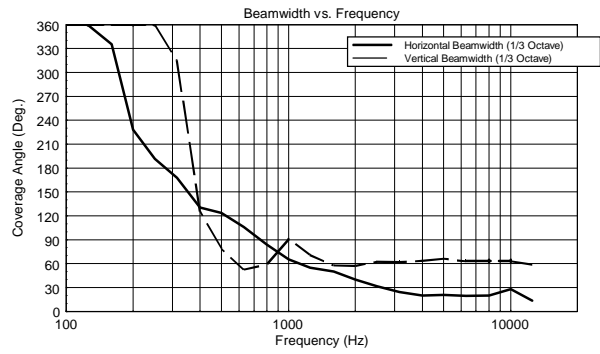
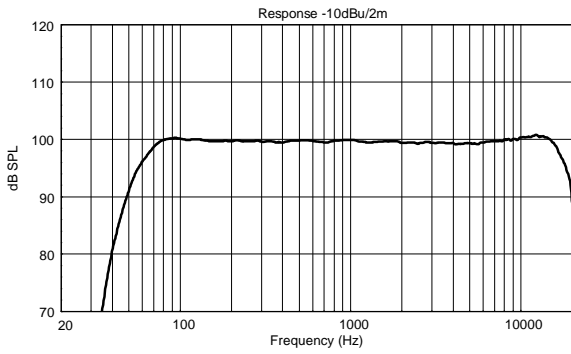

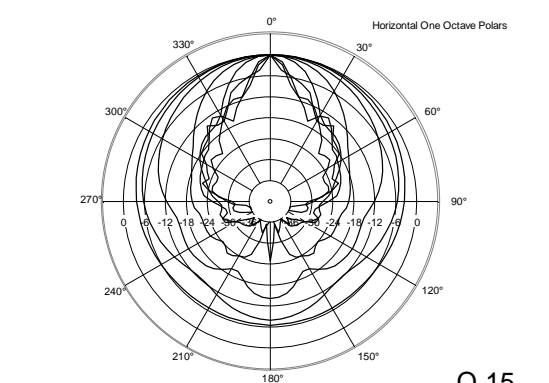
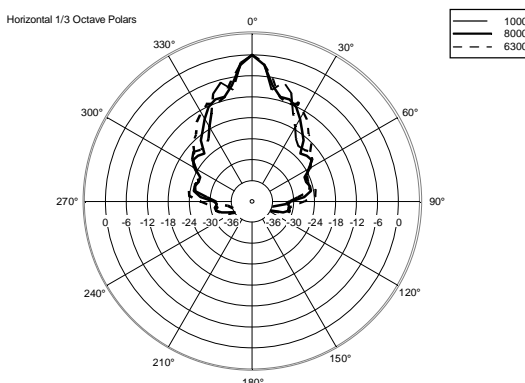
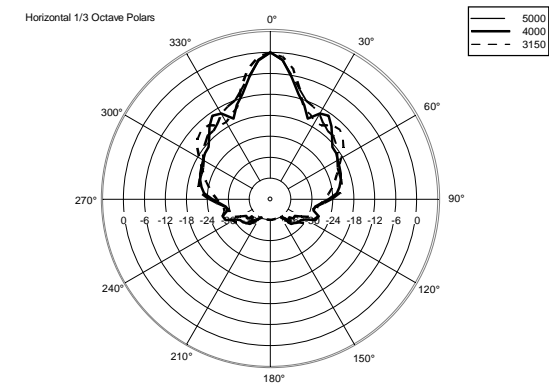
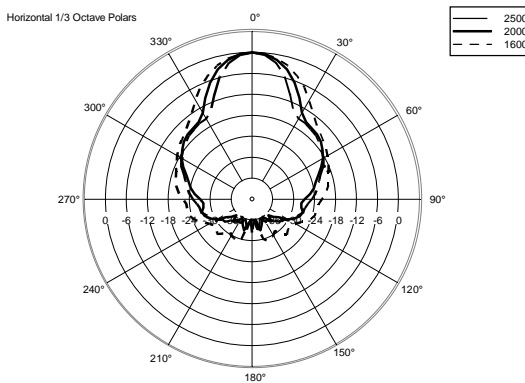
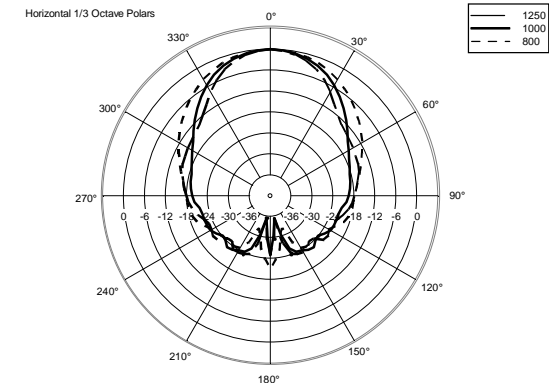
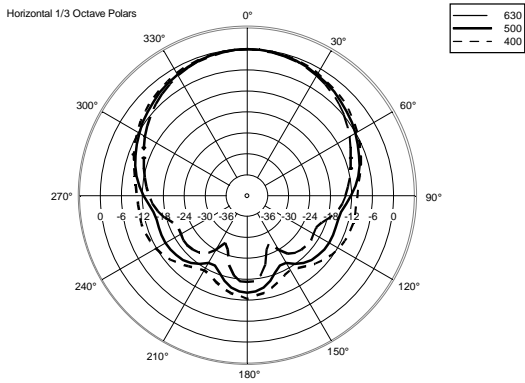
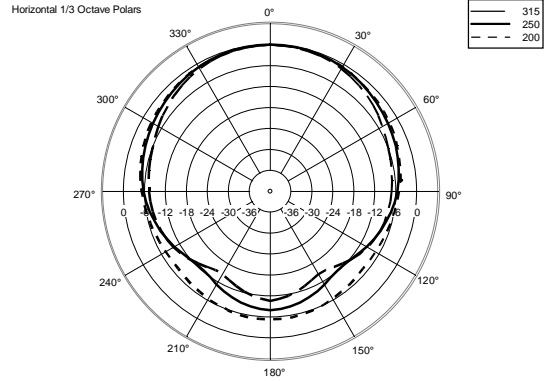
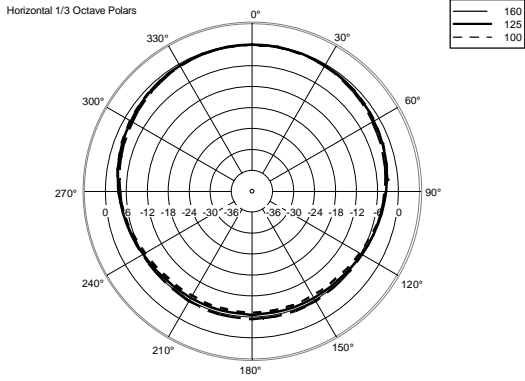

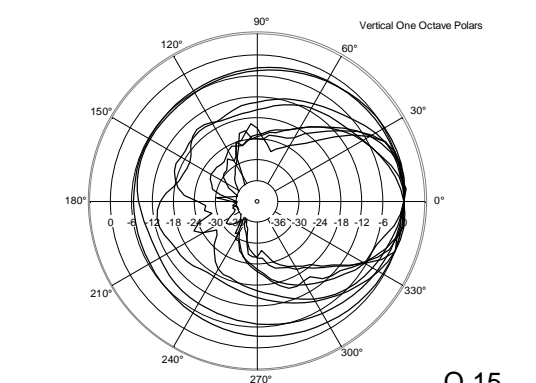
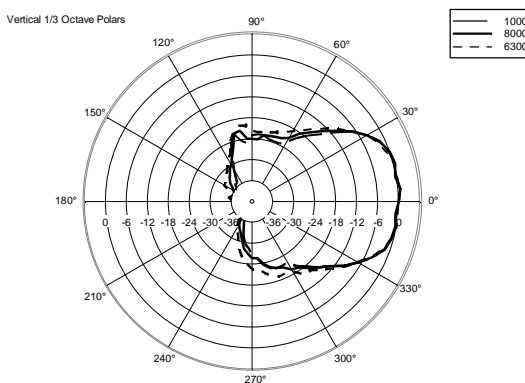
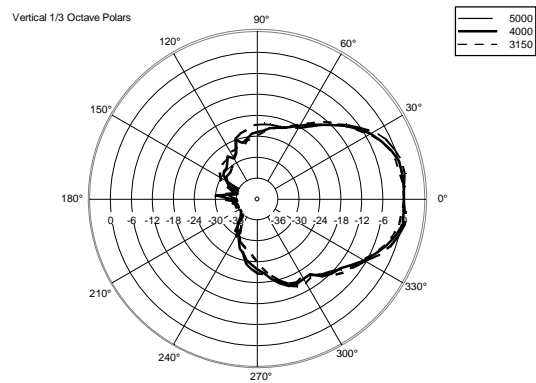
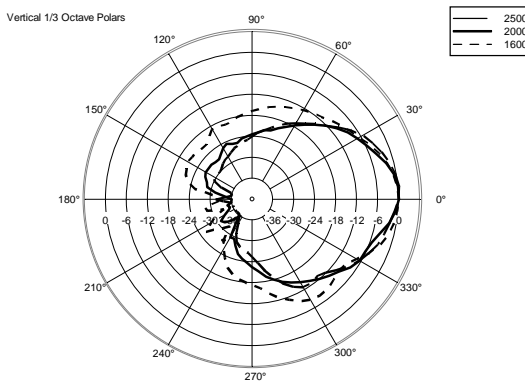
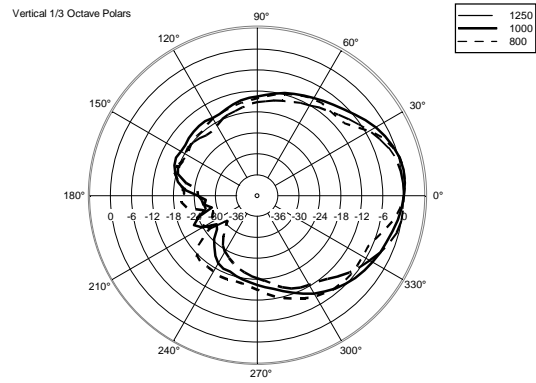
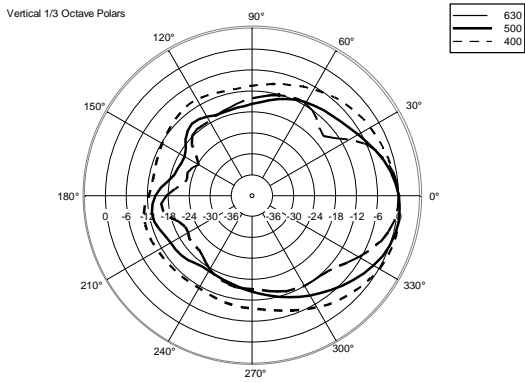
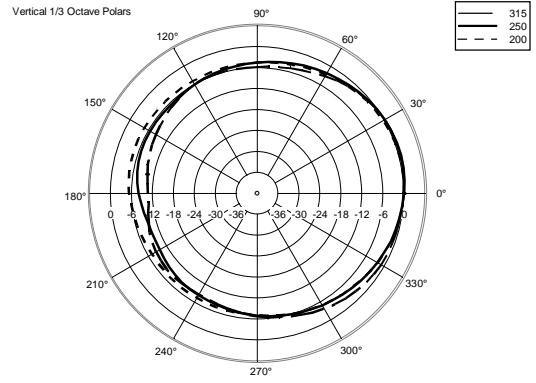
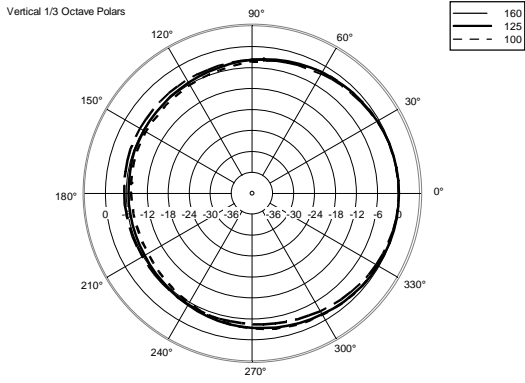

ACCESSORIES

FLY BAR FL-B H Q 15

PART NUMBER **13360456**
EAN: 8024530019099



FLY BAR FL-B V Q 15

PART NUMBER **13360457**
EAN: 8024530019082

FLYING BRACKET 10° - Q 15

PART NUMBER **13360487**
EAN: 8024530019662